

Operating Instructions

Stud welding devices

BMS-8N

BMS-8NV

Stud welding guns

PS-1 and PS-1K

PS-3K(Stativ)

PS-0K



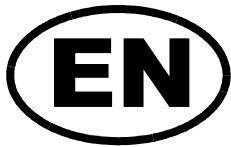

Device numbers

We recommend to enter the device numbers in the list so that they can be accessed quickly if servicing is required.

Device	Type	Serial number
Stud welding device	BMS-8N	
	BMS-8NV	
Stud welding gun	PS-1	
	PS-1K	
	PS-3K	
	PS-3K Stativ	
	PS-0K	

Operating Instructions

Document no.: P00198, 10-2018, translation of the original instructions
(English: P00298)

All information in this document is the property of
Heinz Soyer Bolzenschweißtechnik GmbH.

Revision status

Document	created/amended	Editor	Date
Original	Created	DD	2 October 2018
	Amended	MS	1 February 2021



CONTENTS

1. General information	6
1.1. Validity of the operating instructions	6
1.2. Declarations of conformity	6
1.3. Manufacturer	8
1.4. Instruction, training	8
1.5. Standards and directives	8
2. Important safety instructions	9
2.1. Warning signs used	9
2.2. General safety instructions	10
2.3. Personal protective equipment	13
2.4. Intended use of the stud welding device	14
2.4.1 Incorrect use	14
2.5. Intended use of the stud welding guns	14
2.5.1 Incorrect use	14
2.6. Operating company prerequisites	15
2.6.1 Prerequisites for personnel	15
3. Transport	16
4. Storage, shutdown	16
5. Disposal	16
6. Description of BMS-8N(V) stud welding devices	17
6.1. Type differentiation	17
6.2. Working method	17
6.2.1 Product features	17
6.2.2 Capacitor discharge stud welding	17
6.3. Overview of the controls	19
6.3.1 Support table stud diameter/charging voltage	21
6.3.2 Displaying the operating states	22
6.4. Technical data on BMS-8N(V) stud welding device	23
6.5. Permitted stud welding guns	24
6.6. Cleaning the stud welding device	25

CONTENTS

7. Description of PS-0K stud welding gun	26
7.1. Technical data for the PS-0K stud welding gun	27
7.2. Cleaning of the stud welding gun	28
8. Description of the PS-1 stud welding gun	29
8.1. Technical data for the PS-1 stud welding gun	30
8.2. Cleaning of the stud welding gun	31
9. Description of the PS-1K stud welding gun	32
9.1. Technical data for the PS-1K stud welding gun	33
9.2. Cleaning of the stud welding gun	34
10. Description of the PS-3K and PS-3K Stativ stud welding guns.	35
10.1. Technical data for the PS-3K (Stativ) stud welding gun	36
10.2. Cleaning of the stud welding gun	37
11. Description of the stud chuck.	38
11.1. Adjusting adjustable stud chucks	38
11.2. Installing the stud chuck (gun without support)	39
11.3. Installing the stud chuck (gun with support)	41
12. Setup and connection	43
12.1. Requirements for the installation location	43
12.2. Connection of the stud welding device and the stud welding guns	44
12.2.1 Mains connection	44
12.2.2 Connecting the earth cable	44
12.2.3 Connecting the stud welding gun	46
13. Settings	47
13.1. Adjusting the charging voltage on the stud welding device	47
13.1.1 Switching the display	48
13.1.2 Adjusting the charging voltage	48
14. Welding operation	49
14.1. Carrying out welding	49
14.2. Notes on checking the quality of the weld	50
14.2.1 Visual inspection	50



CONTENTS

14.3. Switching off the device	52
14.4. Welding defects and their causes	53
14.5. Malfunctions with an error message	54
15. Maintenance and repair	56
16. Service	56
17. Warranty conditions	57

1. General information

These operating instructions contain important information and rules for the operation of the devices. Keep these operating instructions in a readily accessible location close to the devices.

In these operating instructions, the term “devices” refers to the stud welding device and the stud welding gun.

Carefully read the operating instructions and any other documents contained in the technical documentation. Pay particular attention to the safety instructions which are intended to help you recognise any possible residual risks and prevent hazards.

The drawings and illustrations in these operating instructions are for illustrative purposes and may vary slightly from the actual equipment.

The manufacturer reserves the right to make technical changes.

1.1 Validity of the operating instructions

These operating instructions apply to the following devices:

Stud welding devices	BMS-8N
	BMS-8NV
Stud welding guns	PS-0K
	PS-1K
	PS-1
	PS-3K
	PS-3K Stativ

1.2 Declarations of conformity

The devices are designed and constructed in accordance with the general accepted codes of practice.



Please note that significant changes to the device will cause the declaration of conformity to become void.

Furthermore, the manufacturer's warranty may be rendered invalid.

Stud welding device

Heinz Soyer Bolzenschweißtechnik
GmbH Inninger Straße 14
82237 Wörthsee

CE - Declaration of Conformity

We herewith declare that the design of the machine described below as well as in the version marketed by us meets the safety and health requirements of the stated guidelines and standards. Any modification of this machine without confirmation shall automatically annul this declaration.

Designation of the machine	<u>Stud welding device</u>
Machine type	<u>BMS-8N</u> <u>BMS-8NV</u>
Machine no.	_____
Applicable EU guidelines	RoHS directive (2011/65/EU) Low-voltage directive (2014/35/EU) EMC directive (2014/30/EU)
Harmonised standards applied, in particular	EN 60 974-1:2018 + A1:2019 EN 60 974-10:2016
National regulations applied	DGUV directive 1
Date	01 February 2021
Manufacturer - signature	 _____
Function of the signatory	CEO



1.3 Manufacturer

The manufacturer of the devices is:

Heinz Soyer Bolzenschweißtechnik GmbH

Inninger Straße 14

82237 Wörthsee

Phone: 0049-8153-885-0

Fax: 0049-8153-8030

Email: info@soyer.de

Web: www.soyer.de, www.soyer.com

1.4 Instruction, training

Soyer offers optional and individual instruction in the operation of the devices.

Moreover, Soyer offers training for customer-specific use of the devices. The tutorial is available at:

<https://www.youtube.com/watch?v=u4JXk8Gzsmg>



Information on the scope and costs of instruction and training can be obtained from Soyer GmbH.



Also see our video instructions at

www.youtube.com/user/SoyerGmbH.

1.5 Standards and directives

The following standards, inter alia, must be observed for carrying out stud welding work and for the qualification of personnel:

- DIN EN ISO 14555 Welding - Arc stud welding of metallic materials
- DIN EN ISO 14732 Welding personnel - Qualification testing of welding operators and weld setters for mechanised and automatic welding of metallic materials
- DIN EN 60974-9 Arc welding equipment - Installation and use
- Technical Bulletin DVS 0903 Capacitor-discharge stud welding with tip ignition
- Technical Bulletin DVS 0904 Instruction for practice - Arc stud welding









2. Important safety instructions

Read the following chapters carefully and follow the safety instructions. Please contact the manufacturer if you are uncertain or an instruction cannot be followed.

The devices have been constructed in accordance with the generally accepted codes of practice and established and usual safety requirements were observed and applied. In order to reach maximum safety, it is absolutely necessary to follow and observe all safety instructions specified in these operating instructions.

2.1 Warning signs used

Warning signs are used in this document, depending on the potential danger of the situation.

Safety and information symbols used in this manual	
	This warning sign indicates imminent danger leading to severe injuries or death.
	This warning sign indicates a potentially dangerous situation that may lead to severe injuries or death.
	This warning sign indicates a potentially dangerous situation that may lead to minor injuries. Without the warning triangle, this warning sign is also used in the event of danger of material damage.
	Additional sign indicating danger from electric current. The additional sign is used in connection with a warning.
	Additional sign indicating the danger of burns. The additional sign is used in connection with a warning.
	Do not touch the surface or the housing: Shock hazard.
	Do not touch or open, danger to unauthorised persons.
	Danger to persons with medical implants such as pacemakers.
	The information sign is not a warning sign. It indicates important and useful information on the subject.

Safety instructions on the device As an additional warning of danger, warning labels can be found on the devices. Warning labels are affixed by the manufacturer and must not be removed. If a warning label is damaged and thus illegible, a new warning label must be affixed immediately.

Warning labels must be obtained from the manufacturer.

2.2 General safety instructions

 **DANGER**



Danger from electric current, general information

When working on live components, there is a danger to life from electric current.

- Work on electric or electronic components may only be performed by trained electrotechnical personnel in accordance with currently applicable electrotechnical regulations.
- Protection devices must not be manipulated or disabled. Protection devices include, for example, housing and housing cover, fuses or power switches.
- If protection devices have to be removed for maintenance work, the device may only be switched on again when all protection devices are installed and their functionality has been checked.
- Starting the device with faulty protection devices is not permitted. Faulty protective devices must be repaired or replaced immediately. Unintentional operation by third parties must be prevented.

! DANGER**Danger from electric current during maintenance and repair work**

When working on live components, there is a danger to life from electric current.

- Work on electric or electronic components may only be performed by trained electrotechnical personnel of Soyer Bolzenschweißtechnik.
- Before performing any work on the stud welding device, the mains switch of the device must be turned off and the mains plug must be disconnected.
- Before performing any work on the stud welding gun, the supply cables to the stud welding device must be disconnected.
- If protection devices have to be removed for maintenance work, the device may only be switched on again when all protection devices are installed and their functionality has been checked.

! DANGER**Danger from magnetic fields**



In the area surrounding the device, strong magnetic fields which may influence medical auxiliary devices and therefore result in danger to life occur during the welding process.

- Persons with electric medical aids (e.g. pacemakers) must stay away from the devices.
- The operating personnel must ensure that persons with medical aids stay away from the devices.

! DANGER**Danger of explosion from inappropriate operation sites in explosive areas**

The device is not designed for use in explosive areas.

- The device must not be installed and operated in explosive areas.

 CAUTION	
<p>Danger of burns from hot surfaces</p> <p>During the welding process, the workpieces and some parts of the welding gun get so hot that touching them may cause burns.</p> <ul style="list-style-type: none"> • Always use personal protective equipment. • Before working on hot parts of the device, check if they have cooled down. 	

 WARNING	
<p>Danger of burns from hot welding spatters</p> <p>During the welding process, dangerous welding spatters may occur.</p> <ul style="list-style-type: none"> • Always use personal protective equipment. 	

 WARNING	
<p>Danger of fire from hot welding spatters</p> <p>Welding spatters or hot workpieces occurring during the welding process may cause danger of fire.</p> <ul style="list-style-type: none"> • Do not store combustible or highly flammable materials in the welding area. 	

2.3 Personal protective equipment





It is recommended to wear personal protective equipment when working with the stud welding device.

⚠ WARNING

Danger from missing or incorrect personal protective equipment

Stud welding may lead to danger of burns, especially due to hot welding spatters. Danger of blinding may also arise due to the occurrence of strong arcs.

- Always wear suitable and closed protective clothing.
- Type and extent of the required protective equipment depend on the respective occurrence of welding spatters and/or arcs. Both occurrences vary, depending on the basic material, stud material, stud size and the required welding performance.
- Please observe the following instructions for protective equipment.

Recommended personal protective equipment	
	<p>Safety goggles</p> <p>Welding spatters and a flash occur during the welding process. In order to protect your eyes, wear appropriate safety goggles with side protection and a filter protector, if necessary.</p>
	<p>Protective gloves</p> <p>During the welding process, the workpieces and components of the welding gun get hot and welding spatters occur. Wear appropriate, incombustible, heat-resistant protective gloves.</p>
	<p>Protective clothing</p> <p>Welding spatters occur during the welding process. Wear appropriate, incombustible and, if necessary, heat-resistant protective clothing.</p>
	<p>Safety footwear</p> <p>Welding spatters occur during the welding process. Wear appropriate, incombustible, heat-resistant safety footwear.</p>
	<p>Hearing protection</p> <p>Relatively loud welding noises may occur, depending on the welding device and the welding application. In that case, wear appropriate hearing protection.</p>



2.4 Intended use of the stud welding device

With the SOYER® BMS-8N capacitor discharge stud welding device, pins and threaded studs from M3 to M8 (M3 to M10 with BMS-8NV) as well as many different weld fasteners made of steel, stainless steel, aluminium and brass can be welded in accordance with DIN EN ISO 13918 (capacitor discharge).

Special studs or diameters upon request.

The stud welding device can only be operated with the welding guns described in chapter "6.5 Permitted stud welding guns" on page 24.

The stud welding device must be operated within the scope of technical data.

2.4.1 Incorrect use

Any use of the device deviating from the intended use is considered as not intended.

Not intended use, unauthorised modification or manipulation of the device will void the declaration of conformity and warranty claims against the manufacturer.

2.5 Intended use of the stud welding guns

With the SOYER® stud welding guns, pins and threaded studs from M3 to M8 (up to M10 with special gun and adapter) as well as many different weld fasteners made of steel, stainless steel, aluminium and brass can be welded in accordance with DIN EN ISO 13918 (capacitor discharge).

Special studs or diameters upon request.

The stud welding gun can only be operated with the stud welding devices described in chapter "6.4 Technical data on BMS-8N(V) stud welding device" on page 23 and chapter "9.1 Technical data for the PS-1K stud welding gun" on page 33.

The stud welding gun can only be operated within the scope of technical data.

2.5.1 Incorrect use

Every use of the welding gun deviating from the intended use is considered as not intended.

Not intended use, unauthorised modification or manipulation of the device will void the declaration of conformity and warranty claims against the manufacturer.

Misusing the gun as a tool, e.g. as a striking tool for checking the welding quality, is not permitted.

2.6 Operating company prerequisites

The operating company of the device must ensure that the prerequisites described in these operating instructions for a safe operation of the device are met.

These include, for example, conditions at the installation location, regulatory requirements on a safe workplace, instruction of operating personnel and qualified personnel in using the device, if applicable, compliance with required maintenance work as well as monitoring the intended use of the device.

These operating instructions must be stored in the vicinity of the device.

The operating company of the device must ensure that all protective devices are present, active and intact before the device is used.

2.6.1 Prerequisites for personnel

Operating personnel

Persons authorised to operate the device must be familiar with the device and trained accordingly. They must have read and understood these operating instructions. When working on the device, they must also be able to avert possible residual danger to themselves or third parties or minimise them as far as possible.

To retain this qualification, safety training must be carried out at least once a year. If necessary, specially trained personnel or the manufacturer must be consulted in case of failure or for maintenance work.

Operators of stud welding devices must have technical expertise for operating and adjusting the device properly as well as for properly carrying out weldings.

If welding personnel has to be qualified for certification of welding, the standards DIN EN ISO 14555 and DIN EN ISO 14732 are to be observed.

Trained electrotechnical personnel

As a general principle, works on live elements may only be performed by qualified electricians. This work must be performed in accordance with the applicable technical rules for electrotechnical devices.



All devices of Soyer Bolzenschweißtechnik GmbH must only be opened by personnel of Soyer or personnel authorised by Soyer.



3. Transport

When transporting the device, make sure that it cannot be damaged. Appropriate packaging can protect the device against weathering effects, especially moisture.

4. Storage, shutdown

During storage or shutdown, make sure to protect the device against dirt and humidity.

Protect the device against unauthorised access by third parties.

5. Disposal

Local environmental directives must be observed when disposing of the device.

Water-endangering as well as environmentally hazardous substances are to be disposed of in accordance with legal regulations.

If applicable, materials must be separated according to regulations.

6. Description of BMS-8N(V) stud welding devices

The main elements of the stud welding device and its features are described in the following.

6.1 Type differentiation

The difference between the device types BMS-8N and BMS-8NV described in this instruction lies in the different performances of the capacitor banks and therefore in the welding performance.

Designation Order number	Feature
BMS-8N P01048	Capacitor bank: 66,000 μ F Maximum welding stud diameter: M8
BMS-8NV P01056	Capacitor bank: 99,000 μ F Maximum welding stud diameter: M8 (M10 with special welding gun)

6.2 Working method

With the SOYER® BMS-8N stud welding device, pins and threaded studs from M3 to M8 (M10 with BMS-8NV and special gun) as well as many different weld fasteners made of steel or stainless steel can be welded in accordance with DIN EN ISO 13918 (capacitor discharge).

Welding of weld fasteners made of aluminium and brass is also possible.

6.2.1 Product features

- Patented “charging circuit” (Pat. No. 199 15 396.5) allowing highest welding sequences during continuous application.
- High performance with a compact design and a small weight.
- Short charging cycles to increase productivity.
- Digital display of the charging voltage or the stud diameter.

6.2.2 Capacitor discharge stud welding

The SOYER® BMS-8N(V) stud welding device operates according to the principle of capacitor discharge with tip ignition.

This system uses the sudden discharge of a capacitor bank to generate arc energy.

Functional principle

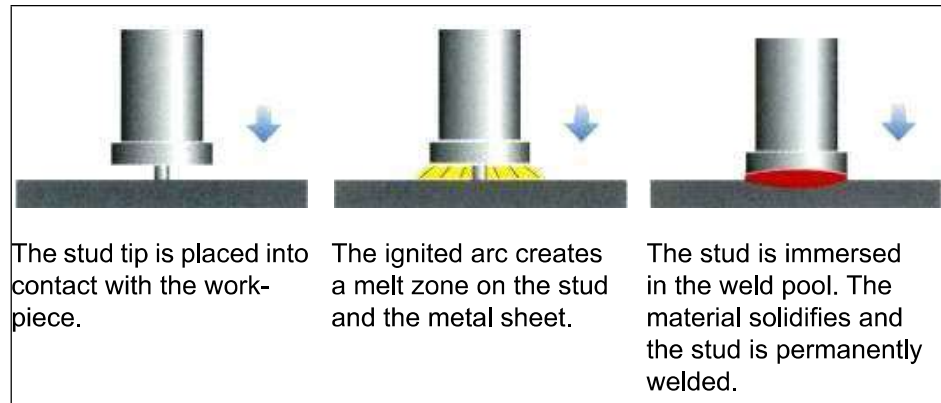

For more information on this subject, please visit: www.soyer.com.

6.3 Overview of the controls

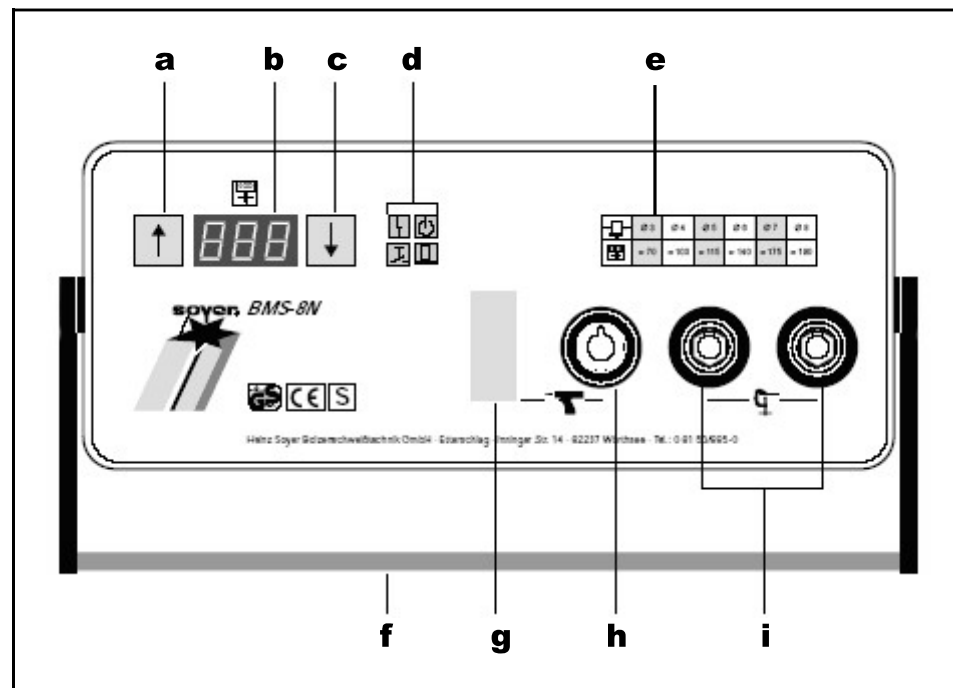

Figure 1: Overview of the front panel

Item	Designation
a	Up arrow key to increase the charging voltage or the stud diameter (depending on the display settings).
b	Display for showing the charging voltage or the stud diameter.
c	Down arrow key to decrease the charging voltage or the stud diameter (depending on the display settings).
d	Display of operating states, see chapter “6.3.2 Displaying the operating states” on page 22.
e	Support table for the selection of the charging voltage fitting the stud.
f	Carrying handle.
g	Socket for the connection of the control cable (stud welding gun).
h	Socket for the connection of the welding cable (stud welding gun).
i	Connector for the connection of the earth cable.

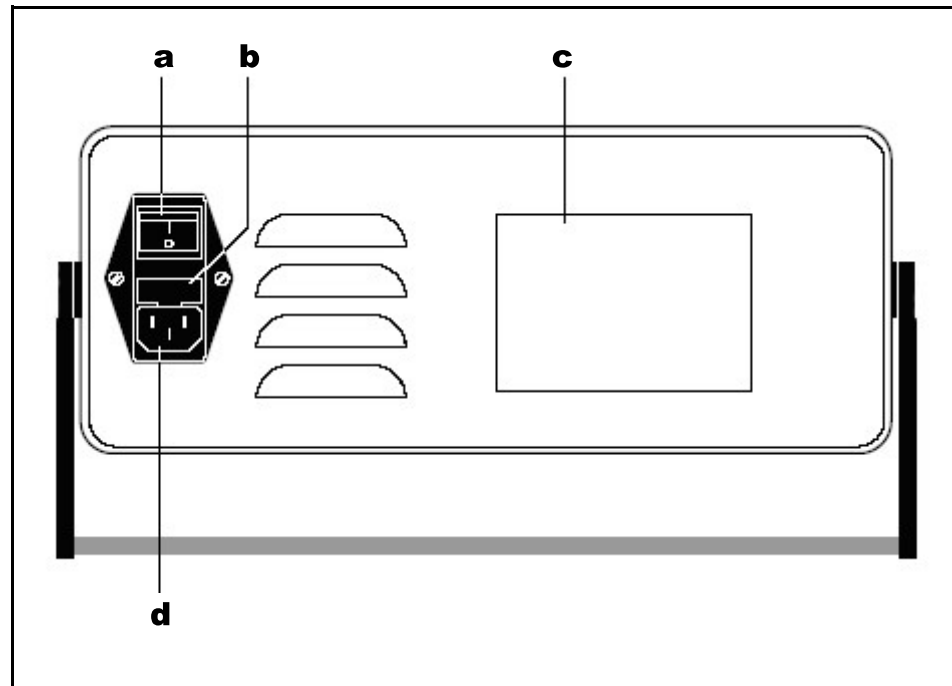

Figure 2: Overview of the back panel

Item	Designation
a	Mains switch for turning the device on/off.
b	Fuses
c	Type plate
d	Mains plug

6.3.1 Support table stud diameter/charging voltage

 <p>a</p>	Ø 3	Ø 4	Ø 5	Ø 6	Ø 7	Ø 8
 <p>b</p>	70	100	115	140	175	190

Figure 3: Support table on the front panel

Item	Designation
a	Row of stud diameters in [mm].
b	Row of the charging voltage assigned to the appropriate stud diameter in [V].

The charging voltage is fixed to the stud diameter and cannot be changed when displaying the stud diameter.

For adjusting the charging voltage, switch to the display of the charging voltage.

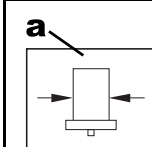
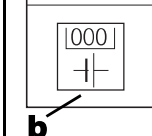
See chapter “13.1 Adjusting the charging voltage on the stud welding device” on page 47.

6.3.2 Displaying the operating states

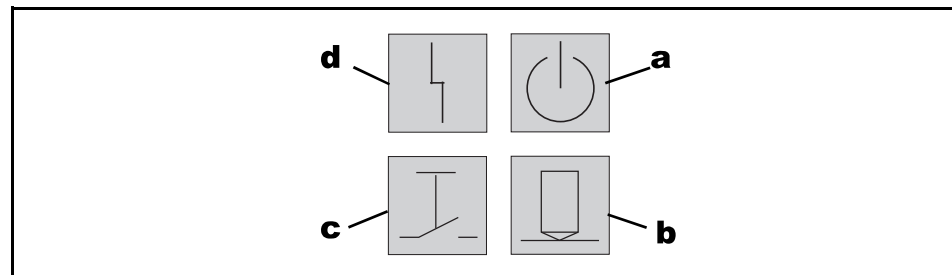

Figure 4: Operating states

Item	Designation
a	<p>Ready</p> <p>In normal operation, the LED lights up when the stud welding device is ready for operation in normal mode.</p>
b	<p>Stud on workpiece</p> <p>The LED lights up when the earth terminal is connected and the stud touches the workpiece.</p>
c	<p>Release</p> <p>The LED lights up when the trigger button on the welding gun is pressed.</p>
d	<p>Malfunction</p> <p>The LED lights up when a malfunction of the stud welding device occurs. See chapter "14.5 Malfunctions with an error message" on page 54.</p>

6.4 Technical data on BMS-8N(V) stud welding device

Designation	BMS-8N / BMS-8NV stud welding device
Welding procedure	Capacitor discharge stud welding
Standard gun	PS-1K
Welding area	M3 - M8 or Ø 3 - 8 mm for steel, stainless steel, aluminium and brass (M8 or Ø 8 for aluminium and brass limited, depending on the respective requirements) (BMS-8NV: M10 with special welding gun)
Power source	Capacitor bank 66,000 µF (Option for BMS-8NV: 99,000 µF)
Charging voltage	50 - 200 V infinitely variable up/down
Welding sequence	<ul style="list-style-type: none"> • BMS-8N: Ø 3 mm up to 20 studs/min, Ø 6 mm up to 10 studs/min • BMS-8NV: Ø 3 mm up to 20 studs/min, Ø 8 mm up to 7 studs/min
Mains connection	230 V, 50 Hz, 10 A (see type plate) Upon request, the device can be adapted to a grid operation of 115 V, 60 Hz.
Fuse	M 10 A (fuse 5 x 20 mm semi time-lag)
Cooling method	F
Protection class	IP 21
Dimensions	295 x 170 x 295 mm (w x h x d)
Weight approx.	10 kg
Colour	RAL 5009 azure blue
Subject to technical changes	

6.5 Permitted stud welding guns

WARNING

Hazards due to wrong gun

Hazards for the operator may occur when a wrong welding gun is used.

- Only use welding guns hereinafter permitted by Soyer.



The use of other guns or guns from another manufacturer will invalidate the declarations of conformity and warranties of Soyer.

Overview of permitted stud welding guns

Gun	Stud welding device	
	BMS-8N	BMS-8NV
PS-0K	M3 - M8	M3 - M8
PS-1	M3 - M8	M3 - M8
PS-1K(*)	M3 - M8	M3 - M8
PS-3K	M3 - M8	M3 - M8
PS-3K Stativ	M3 - M8	M3 - M10
SK-1 T-Nut(**)	M3 - M8	M3 - M8

(*) Standard gun

(**) Desk-type welding machine, not described in these instructions, see separate instructions.

6.6 Cleaning the stud welding device

! DANGER

Dangers during cleaning

Improper cleaning of the stud welding device can endanger personnel.

- The device may only be cleaned by trained specialists.
- Before any cleaning work is done, the stud welding device must be disconnected from the main power supply and secured against accidental switch-on.
- Work on electrical devices and components may only be performed by skilled electricians in accordance with electrotechnical regulations.
- Make sure that no liquids get into the device.

Do not use aggressive detergents for cleaning the device.

Please make sure that any cleaning waste is disposed of in an environmentally safe manner. Please observe the instructions of the detergent manufacturer.

CAUTION

Damage to the device due to incorrect cleaning

Incorrect cleaning may cause damage to the device.

- Make sure that no liquids get into the device.
- Do not use aggressive detergents for cleaning the device.

The frequency of cleaning depends on the operating conditions of the stud welding device.

7. Description of PS-0K stud welding gun

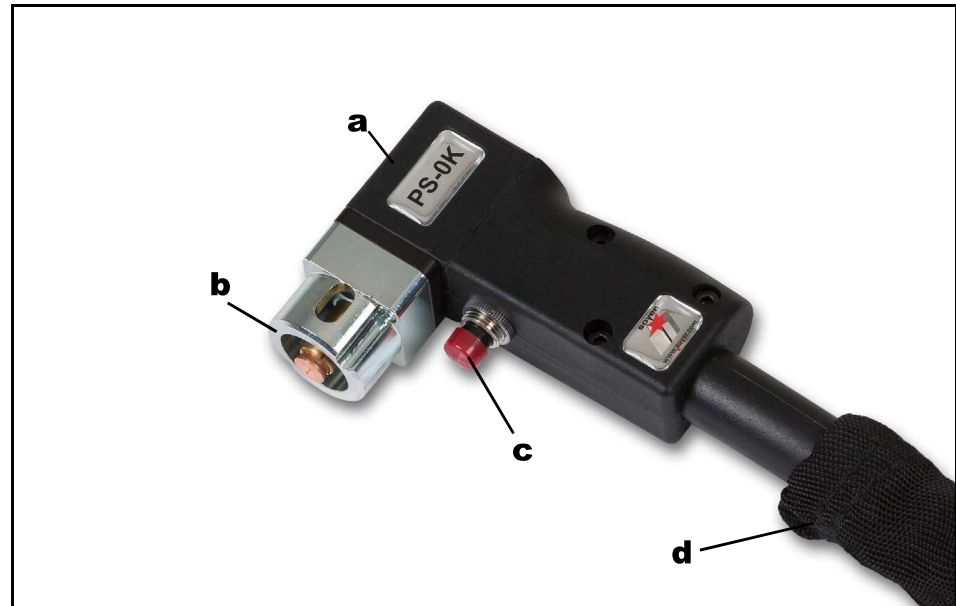

Figure 5: PS-0K stud welding gun

Item	Designation
a	PS-0K stud welding gun, contact gun without lifting magnet
b	Support tube
c	Release button
d	Power and control cable for connection to the stud welding device.

Due to a projection on the support tube and a spring in the gun, the stud of this gun is pressed firmly to the workpiece (contact gun).

The stud is not lifted before welding.



The PS-0K stud welding gun may only be operated with the stud welding devices specified in the technical data.

7.1 Technical data for the PS-0K stud welding gun

Technical data for the PS-0K stud welding gun

Designation	PS-0K stud welding gun (contact gun)
Item no.	P02102
Welding procedure	Capacitor discharge stud welding
Stud diameter	M3 - M8
Stud chuck	Adjustable
Stud length	Adjustable stud chuck up to a maximum of 35 mm
Stud welding devices	<p>The gun is approved for operation on the following SOYER® stud welding devices:</p> <ul style="list-style-type: none"> • BMS-6 ISO • BMS-8N • BMS-8NV • BMS-9 (*) • BMS-9V (*) • BMS-10N • BMS-10NV • BMS-10P
Weight approx.	0.3 kg without cable
Subject to technical changes	

(*) With adapter plug, see technical data for the stud welding device.



7.2 Cleaning of the stud welding gun

On a regular basis, remove slag and welding spatters from the gun and the support tube using a suitable tool.

The frequency of cleaning depends on the operating conditions of the stud welding gun.

CAUTION

Risk of injury during cleaning

Welding spatters and slag can be sharp-edged.

- Wear protective gloves when cleaning.



We recommend the use of SOYER® separating spray in order to prevent impurities from welding spatters and slag and to simplify the cleaning process.

8. Description of the PS-1 stud welding gun

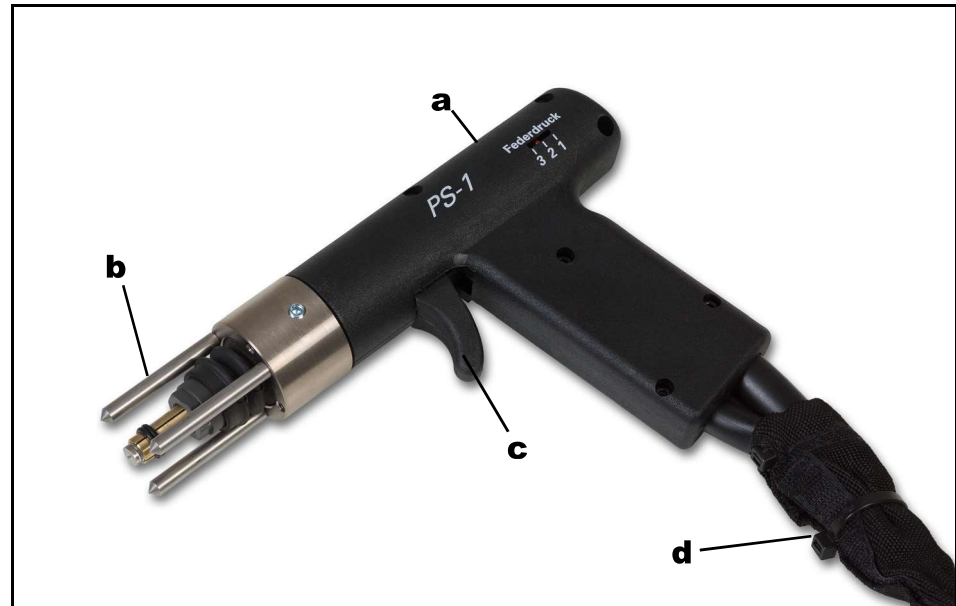

Figure 6: PS-1 stud welding gun

Item	Designation
a	PS-1 stud welding gun, operating mechanically
b	Gun legs
c	Release button
d	Power and control cable for connection to the stud welding device.

The mechanical PS-1 stud welding gun allows the welding of studs with ignition tip accurately on scribed or centre marked surfaces without requiring any auxiliary devices. The spring pressure is adjustable in order to ensure optimal welding results.

The stud is not lifted before welding.



The PS-1 stud welding gun may only be operated with the stud welding devices specified in the technical data.



8.1 Technical data for the PS-1 stud welding gun

Technical data for the PS-1 stud welding gun

Designation	PS-1 stud welding gun
Item no.	P02110
Welding procedure	Capacitor discharge stud welding
Stud diameter	M3 - M8
Stud chuck	Adjustable
Stud length	Adjustable stud chuck up to a maximum of 35 mm Longer stud lengths with optional accessory possible
Stud welding devices	The gun is approved for operation on the following SOYER® stud welding devices: <ul style="list-style-type: none"> • BMS-6 ISO • BMS-8N • BMS-8NV • BMS-10N • BMS-10NV • BMS-10P
Weight approx.	0.5 kg without cable
Subject to technical changes	

8.2 Cleaning of the stud welding gun

On a regular basis, remove slag and welding spatters from the gun and the gun legs using a suitable tool.

The frequency of cleaning depends on the operating conditions of the stud welding gun.

CAUTION

Risk of injury during cleaning

Welding spatters and slag can be sharp-edged.

- Wear protective gloves when cleaning.



We recommend the use of SOYER® separating spray in order to prevent impurities from welding spatters and slag and to simplify the cleaning process.

9. Description of the PS-1K stud welding gun



Figure 7: PS-1K stud welding gun

Item	Designation
a	PS-1K stud welding gun, contact gun without lifting magnet
b	Support tube
c	Release button
d	Power and control cable for connection with the stud welding device.

Due to a projection on the support tube and a spring in the gun, the stud of this gun is pressed firmly to the workpiece (contact gun).

The stud is not lifted before welding.



The PS-1K stud welding gun may only be operated with the stud welding devices specified in the technical data.

9.1 Technical data for the PS-1K stud welding gun

Technical data for the PS-1K stud welding gun

Designation	PS-1K stud welding gun (contact gun)
Item no.	P02117
Welding procedure	Capacitor discharge stud welding
Stud diameter	M3 - M8
Stud chuck	Adjustable
Stud length	Adjustable stud chuck up to a maximum of 35 mm Longer stud lengths with optional accessory possible
Stud welding devices	The gun is approved for operation with the following SOYER® stud welding devices: <ul style="list-style-type: none"> • BMS-6 ISO • BMS-8N • BMS-8NV • BMS-9 (*) • BMS-9V (*) • BMS-10N • BMS-10NV • BMS-10P
Weight approx.	0.4 kg without cable
Subject to technical changes	

(*) With adapter plug, see technical data on the stud welding device.



9.2 Cleaning of the stud welding gun

On a regular basis, remove slag and welding spatters from the gun and the support tube using a suitable tool.

The frequency of cleaning depends on the operating conditions of the stud welding gun.

CAUTION

Risk of injury during cleaning

Welding spatters and slag can be sharp-edged.

- Wear protective gloves when cleaning.



We recommend the use of SOYER® separating spray in order to prevent impurities from welding spatters and slag and to simplify the cleaning process.

10. Description of the PS-3K and PS-3K Stativ stud welding guns



Figure 8: PS-3K and PS-3K Stativ stud welding guns

Item	Designation
a	PS-3K stud welding gun, contact gun without lifting magnet
b	Gun legs
c	Release button
d	Power and control cable for connection with the stud welding device.
e	PS-3K stud welding gun with support

Due to a projection on the gun legs and a spring in the gun, the stud of this gun is pressed firmly to the workpiece (contact gun).

The stud is not lifted before welding.

The gun model with an adjustable support can take stud chucks of up to M10.



The PS-3K and PS-3K Stativ stud welding guns may only be operated with the stud welding devices specified in the technical data.

10.1 Technical data for the PS-3K (Stativ) stud welding gun

Technical data on the PS-3K (Stativ) stud welding gun

Designation	Stud welding gun PS-3K (contact gun) PS-3K Stativ
Item no.	PS-3K: P02131 PS-3K Stativ: P02143
Welding procedure	Capacitor discharge stud welding
Stud diameter	PS-3K: M3 - M8 PS-3K Stativ: M3 - M12
Stud chuck	Adjustable
Stud length	PS-3K: Adjustable stud chuck up to a maximum of 35 mm Longer stud lengths with optional accessory possible PS-3K Stativ: Stud length up to 60 mm, without optional accessory.
Stud welding devices	The gun is approved for operation on the following SOYER® stud welding devices: <ul style="list-style-type: none"> • BMS-6 ISO • BMS-8N • BMS-8NV • BMS-9 (*) • BMS-9V (*) • BMS-10N • BMS-10NV • BMS-10P
Weight approx.	0.9 kg without cable
Subject to technical changes	

(*) With adapter plug, see technical data on the stud welding device.

10.2 Cleaning of the stud welding gun

On a regular basis, remove slag and welding spatters from the gun and the gun legs/support using a suitable tool.

The frequency of cleaning depends on the operating conditions of the stud welding gun.

CAUTION

Risk of injury during cleaning

Welding spatters and slag can be sharp-edged.

- Wear protective gloves when cleaning.



We recommend the use of SOYER® separating spray in order to prevent impurities from welding spatters and slag and to simplify the cleaning process.

11. Description of the stud chuck

In principle, every welding gun is provided with a stud chuck that matches the welding stud. There are two types of stud chucks:

- Adjustable stud chucks
- Non-adjustable stud chucks

Corresponding to the stud diameter, stud chucks must be installed/changed in the gun.

In addition, adjustable stud chucks must be set to the stud length.

Only guns with adjustable stud chucks are described in these instructions.

11.1 Adjusting adjustable stud chucks

Adjustable stud chucks must be adjusted to the length of the welding stud and, if necessary, to the gun size.

The standard stud chuck can hold studs with a length of up to 35 mm.

i

For welding guns with a short housing (e.g. PS-1K or PS-0K), it may be necessary to shorten the stop screw of longer welding studs.

When the adjusting screw is too long, the stud chuck cannot be fully plugged into the gun or the stud lift cannot be properly executed during welding.





Adjusting the stud chuck

Adjusting an adjustable stud chuck

Step 1:	Select the stud chuck according to the required stud diameter.
Step 2:	Insert the stud into the stud chuck.

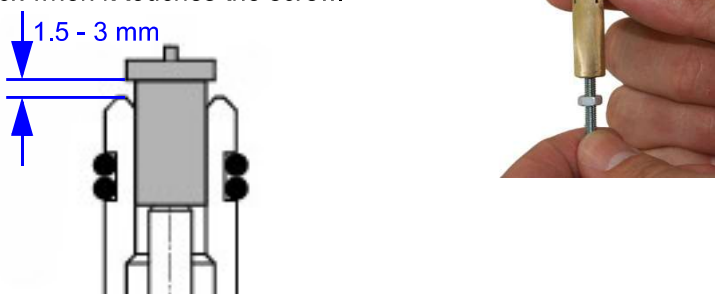

Adjusting an adjustable stud chuck

Step 3:	Adjust the stop screw so that the top of the flange of the stud sits between 1.5 mm and 3 mm above the stud chuck when it touches the screw.	
Step 4:	Fix the stop screw with the lock nut.	
The adjustment is complete.		





11.2 Installing the stud chuck (gun without support)

The installation of the stud chuck is shown using the example of the PS-1K gun. The installation of the stud chuck into other gun types is carried out in the same way.

Installing the stud chuck (gun without support).

Step 1:	<div style="background-color: #ffcc00; padding: 5px; display: inline-block;">⚠ WARNING</div> Switch off the stud welding device when the gun is connected to it.	
Step 2:	Set the stud chuck to the required stud.	
Step 3:	Remove the gun support tube.	
<div style="display: flex; align-items: center;"> <div style="background-color: #333; color: white; border-radius: 50%; width: 20px; height: 20px; display: flex; align-items: center; justify-content: center; margin-right: 5px;">i</div> <p>It is not mandatory to remove the support tube, however this makes use easier.</p> </div>		

Installing the stud chuck (gun without support).

Step 4:	Undo the union nut. 
Step 5:	If there is still a stud chuck in the gun, remove it.
Step 6:	Slide the stud chuck up to the stop into the spring piston of the gun. 
Step 7:	Hand-tighten the union nut. 
Step 8:	Plug the support tube onto the gun. 

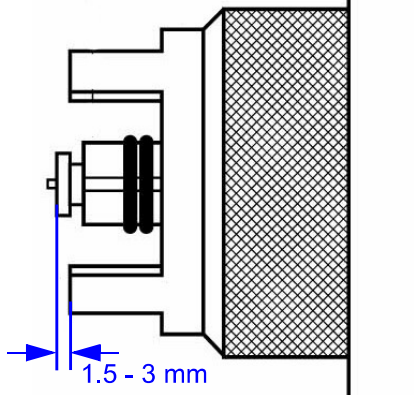

Installing the stud chuck (gun without support).

Step 9:	Insert a stud and check the stud protrusion. The stud / stud flange must protrude 1.5 - 3 mm from the support tube. If applicable, correct the setting of the stud chuck (see chapter " Adjusting the stud chuck" on page 38).	
The assembly is complete.		

11.3 Installing the stud chuck (gun with support)

The installation of the stud chuck is shown using the example of the PS-3K Stativ gun. The installation of the stud chuck into other guns with support is carried out in the same way.

Installing the stud chuck (gun with support).

Step 1:	<div style="background-color: #ffcc00; padding: 5px; display: inline-block;">  WARNING </div> Switch off the stud welding device when the gun is connected to it.	
Step 2:	Set the stud chuck to the required stud.	
Step 3:	Undo the clamping screws of the support.	
Step 4:	Undo the union nut (a). If there is still a stud chuck (b) in the gun, remove it.	

Installing the stud chuck (gun with support).

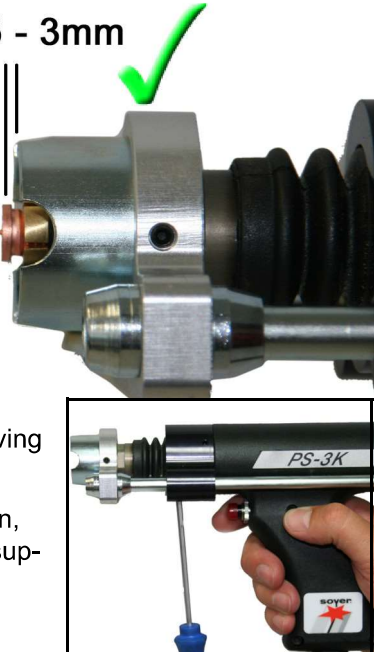
<p>Step 5:</p>	<p>Slide the stud chuck (a) up to the stop into the spring piston of the gun.</p> <p>Tighten the union nut (b).</p>	
<p>Step 6:</p>	<p>Insert a stud and check the stud protrusion.</p> <p>The stud / stud flange must protrude 1.5 - 3 mm from the support tube.</p> <p>If applicable, correct the settings of the stud chuck by moving the support.</p> <p>After adjusting the stud protrusion, tighten the clamp screws of the support.</p>	<p>1,5 - 3mm</p> 
<p>The assembly is complete.</p>		

12. Setup and connection

12.1 Requirements for the installation location

The installation location for the stud welding device must be clean and dry. Observe the permissible temperatures in chapter “6.4 Technical data on BMS-8N(V) stud welding device” on page 23. Ensure that ventilation for the stud welding device is sufficient. Do not install the stud welding device in an unventilated room. There is a danger of overheating.

Ensure that the installation surface is flat, clean and stable.

The installation location and workplace must comply with legal requirements.

Ensure that the installation location has a good accessibility for maintenance work.

Make sure that the stud welding device cannot be soiled by dust (especially metal dust or chips) caused by work in the immediate surroundings (e.g. grinding work).

 **DANGER**



Danger from humid operation site or mobile use

There is a danger of electrocution when operating the stud welding device in a humid environment.

- The stud welding device must only be operated stationary and in closed and dry rooms. Mobile use is not permissible.

 **CAUTION**



Danger from welding vapours

Vapours that are dangerous to health may occur, depending on the material of the workpiece and/or the welding stud.

- Ensure suitable suction of welding vapours, if necessary.

12.2 Connection of the stud welding device and the stud welding guns

12.2.1 Mains connection

After installation, connect the stud welding device to power supply using the mains plug. See chapter “6.4 Technical data on BMS-8N(V) stud welding device” on page 23.

12.2.2 Connecting the earth cable

A secure earth connection must be established between the workpiece onto which the studs are welded and the stud welding device.

Plug two earth cables into the sockets (a) and turn the plugs to the right up to the stop.

Then connect the earth cable to the workpiece (ensure a conductive connection).

Then attach the earth clamps to the workpiece so that the welding gun is positioned in the centre of the connecting line of the two earth clamps. This guarantees a symmetrical current distribution around the stud as well as good welding results.

Difficult areas are weldings on the edge of the workpiece or great inhomogeneities in material thickness, i.e. the sheet thickness varies by a few millimetres or additional material is welded or riveted to the material. This also includes stud welding on vertical sections.

In order to achieve good welding results, carry out several test weldings under different conditions. Simply change the position of the earth clamps or turn the welding gun, for example.

You can determine the symmetry and quality of the arc during the preweld current test and afterwards optimise them by accordingly combining the earth connection and the gun position.

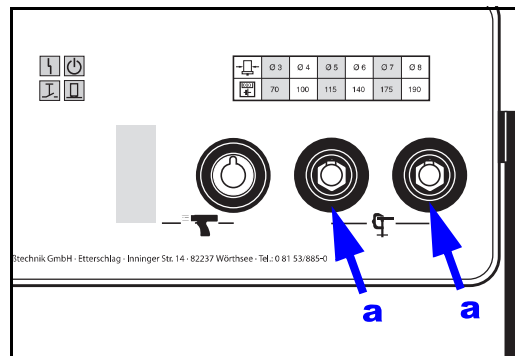

Blow effect
Blow effect due to earth connection or workpiece geometry

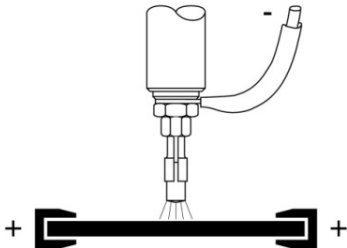
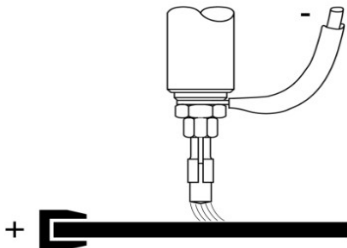
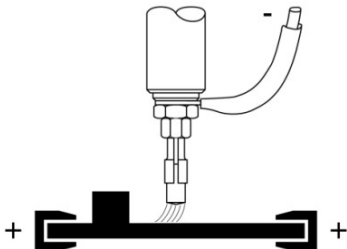
Blow effect	Explanation
	<p>Symmetrical earth connection</p> <p>Ideal condition, stud is located in the centre of the two earth connections.</p>
	<p>Asymmetrical earth connection</p> <p>The arc is deflected to the side where there is a lower current density.</p>
	<p>Workpiece geometry</p> <p>Additional workpiece masses disturb the arc symmetry.</p>

12.2.3 Connecting the stud welding gun

Only use the welding guns approved by the manufacturer. See chapter “6.5 Permitted stud welding guns” on page 24.

Plug the welding cable into the socket (a) and turn the plug to the right up to the stop.

Plug the control cable into the control cable socket (b).

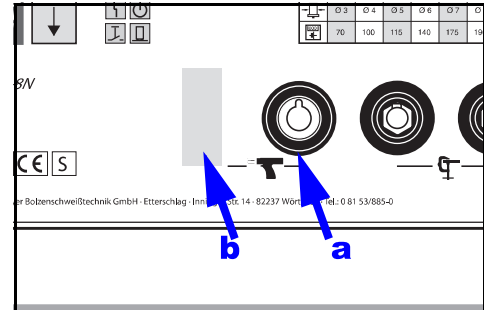

13. Settings

The stud welding device and the stud welding gun must be matched and adjusted for the respective work.

13.1 Adjusting the charging voltage on the stud welding device

In the following, it is described how the charging voltage is adjusted.







In order to achieve an optimal stud welding result, carrying out some test welds with different settings is necessary.

The charging voltage to be set on the stud welding device depends, among others, on the following influencing factors:

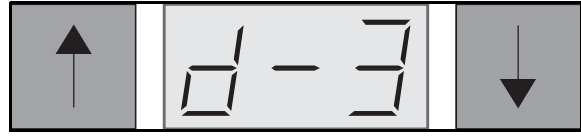
- Material of the workpiece
- Thickness of the workpiece
- Material of the welding stud
- Diameter of the welding stud

With the arrow keys on the display, the charging voltage or the stud diameter can be adjusted.

The charging voltage or the stud diameter is indicated on the display.

<p><i>Display of charging voltage in volt.</i></p> <p>With the arrow keys, the charging voltage can be adjusted in steps of 1 volt.</p>															
<p><i>Display of the stud diameter.</i></p> <p>d-3 is equivalent to a charging voltage of 70 volt. Please refer to the table on the front panel.</p>															
<p>Table on the front panel.</p> <table border="1" data-bbox="1050 1597 1385 1675"> <thead> <tr> <th></th> <th>Ø 3</th> <th>Ø 4</th> <th>Ø 5</th> <th>Ø 6</th> <th>Ø 7</th> <th>Ø 8</th> </tr> </thead> <tbody> <tr> <td></td> <td>70</td> <td>100</td> <td>115</td> <td>140</td> <td>175</td> <td>190</td> </tr> </tbody> </table> <p>The charging voltage is fixed to the stud diameter and cannot be changed when displaying the stud diameter.</p> <p>Switch to the display of the charging voltage to precisely adjust the charging voltage.</p>			Ø 3	Ø 4	Ø 5	Ø 6	Ø 7	Ø 8		70	100	115	140	175	190
	Ø 3	Ø 4	Ø 5	Ø 6	Ø 7	Ø 8									
	70	100	115	140	175	190									

13.1.1 Switching the display

Switching the display of the charging voltage and the stud diameter

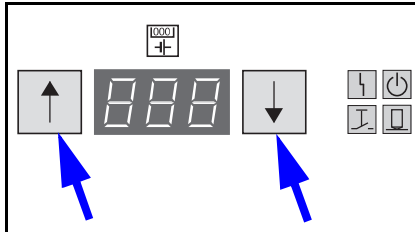
Step 1:	Switch off the device at the mains switch.
Step 2:	Press and hold both arrow keys. 
Step 3:	Switch on the device and hold the arrow keys for about 3 seconds. <i>When the display changes, release the arrow keys. The device is ready.</i>

13.1.2 Adjusting the charging voltage

Adjusting the charging voltage

Step 1:	Connect the device as described in chapter "12.2 Connection of the stud welding device and the stud welding guns" on page 44.
Step 2:	Either select the required stud diameter or the required charging voltage (for switching the display see chapter "13.1.1 Switching the display" on page 48).
Step 3:	<p>When displaying the charging voltage, it can be increased or decreased by pressing the arrow keys $\uparrow\downarrow$.</p>  <p>The charging voltage cannot be adjusted when displaying the stud diameter. A fix charging voltage is assigned to every stud diameter (see table on the front panel).</p>
<p>The charging voltage is adjusted.</p> <p>i The adjusted value is saved and remains unchanged even after switching the device off and back on again.</p>	

14. Welding operation

In the following, it is described how weldings are carried out and how possible welding errors can be avoided.

14.1 Carrying out welding

In the following, it is described how weldings are carried out with a stud welding gun.

 DANGER
<p>Danger from incorrect operation</p> <p>During stud welding, incorrect operation of the devices may cause many dangers.</p> <ul style="list-style-type: none"> • Before using the stud welding device, see chapter “2. Important safety instructions” on page 9. • If you have any problems understanding the operating instructions, contact the manufacturer, Soyer.

Carrying out welding

Step 1:	 WARNING Before welding, see chapter “2. Important safety instructions” on page 9
Step 2:	<p>Connect the gun to the stud welding device (see chapter “12.2 Connection of the stud welding device and the stud welding guns” on page 44).</p> <p>Check if a connection adapter may be required.</p>
Step 3:	<p>Insert the appropriate stud chuck and a welding stud (see the descriptions of the stud welding guns and chapter “11. Description of the stud chuck” on page 38).</p> <p>Only use SOYER® welding studs.</p>
Step 4:	<p>Check the charging voltage (see chapter “13.1 Adjusting the charging voltage on the stud welding device” on page 47).</p>
Step 5:	<p>Ensure that the welding points on the stud and workpiece are metallicly bright.</p>

Carrying out welding

Step 6:	<p>Press the gun onto the workpiece at an angle of 90 degrees.</p> <div data-bbox="874 360 1153 591" data-label="Image">  </div> <p>When using a contact gun, press it firmly against the spring force.</p>
Step 7:	<p>Push the release button of the gun.</p> <p><i>Welding is carried out.</i></p> <p>i During the welding process, hold the gun steadily and only remove it vertically from the welded stud after the welding process is finished. By doing so, widening or damaging the stud chuck is avoided.</p>
The welding process is finished.	

14.2 Notes on checking the quality of the weld

If the SOYER® stud welding equipment is handled correctly and the correct materials are selected, the strength of the welding joint (welding zone) is always higher than the strength of the stud or the base material.

In practice, the following production control tests have proved successful:

- Visual inspection
- Bend test

For further information, see standard:



DIN EN ISO 14555 Arc stud welding of metallic materials or Technical Bulletin DVS 0904 Instruction for practice - Arc stud welding.

14.2.1 Visual inspection

The visual inspection serves as a rough check for major defects. The uniformity of the weld is assessed.

The following table serves as an aid for the assessment of the welding result:

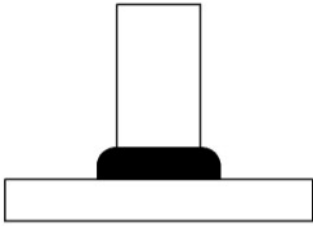
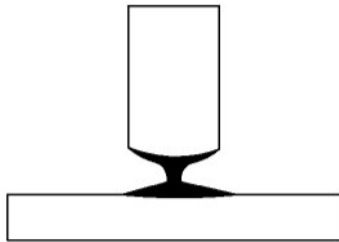
Visual inspection

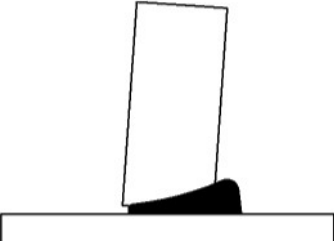
Welding image	Note
	<p>Good welding joint. Optimum setting.</p> <p>Even, bright and closed welding bead.</p>
	<p>Poor welding joint, e.g. because the welding energy is too high or the immersion distance / lift is too small.</p> <p>The stud is constricted to the welding joint. The stud is only partially welded.</p>
	<p>Poor welding joint, e.g. because the welding energy is too low or the lift is too short.</p> <p>The welding bead is weak and unevenly formed.</p>
	<p>Poor welding joint, e.g. due to a blow effect or a welding gun that was shaken or applied at a slant.</p> <p>The stud flange is not welded completely and has visible imperfections. Undercuts are visible.</p>

14.3 Switching off the device

Switch off the stud welding device at the mains switch.

The connected welding gun is switched off automatically.

Ensure that the stud welding device cannot be switched on and used by unauthorised persons.

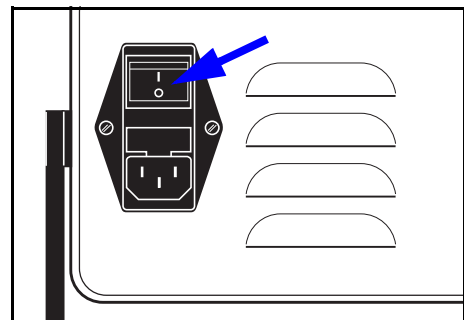

14.4 Welding defects and their causes

In the following, the most common welding errors, possible causes and troubleshooting are described.

Please contact Heinz Soyer Bolzenschweißtechnik GmbH if a problem cannot be solved.

Error	Possible cause and troubleshooting
Device does not weld, no sparking	Stud welding device is not switched on. <ul style="list-style-type: none"> • When switching on the device, the red indicator light “Ready” must light up.
	Welding points or earth connection points on the workpiece are not metallicly bright. The LED display “Stud on workpiece” does not light up (see chapter “6.3.2 Displaying the operating states” on page 22). <ul style="list-style-type: none"> • Prepare the workpiece or stud. Grind connection points to a bright metal finish.
Scorched stud thread	Stud is too loose in the stud chuck. <ul style="list-style-type: none"> • Press or retighten the stud chuck.
	Stud chuck is worn. <ul style="list-style-type: none"> • Exchange stud chuck.
Varying welding results with unchanged settings	Stud is too loose or not fully inserted into the stud chuck. <ul style="list-style-type: none"> • Push in the stud until stop. • If necessary, exchange the stud chuck.
	Welding studs manufactured inaccurately. <ul style="list-style-type: none"> • Only use SOYER® welding studs.
Stud is not welded to the whole flange surface, strength of the welding is insufficient	Contamination on the surface of the workpiece is too heavy. <ul style="list-style-type: none"> • Clean or grind the surface of the workpiece to a bright metal finish.
	The front surface of the welding stud is deformed. <ul style="list-style-type: none"> • Use new welding studs. • Only use SOYER® welding studs
	The welding gun was placed in tilted position. <ul style="list-style-type: none"> • Position the welding gun evenly.

14.5 Malfunctions with an error message

⚠ DANGER

Dangers during troubleshooting

During troubleshooting, various dangers may occur.

- All devices of Soyer Bolzenschweißtechnik GmbH may only be opened by personnel of Soyer or personnel authorised by Soyer.
- For troubleshooting, the device must be disconnected from the main power supply and secured against accidental switch-on.

When there is a stud welding device malfunction, an error message (code) appears on the display.



Error code	Description	Possible cause
E01	Safety shutdown as a voltage of more than 25 V was measured for more than approx. 40 ms on the welding power sockets.	<ul style="list-style-type: none"> • Stud inserted too deep into the stud chuck • Mechanical problems with the gap welding gun • External voltage of other welding devices • Error in the device (thyristor short circuit)
E02	Error when charging the capacitors	<ul style="list-style-type: none"> • Welding capacitors faulty (leakage current) • Charging current source faulty

Error code	Description	Possible cause
E03	Safety circuit malfunction	<ul style="list-style-type: none"> • Defective quick-discharging resistor • Safety relay is clamping or sticking • Switching times of the safety relay too long
E04	Incorrect mains voltage	<p>The mains voltage must be between 90...130 V at 60 Hz or 180...275 V at 50 Hz.</p> <p>The required mains voltage can be found on the type plate.</p>
E05	Excess temperature of the electronic equipment	<p>During high welding sequences, the device may be exposed to an increased ambient temperature (>45°C) or direct sunlight.</p>
E06	Error in the welding gun	<ul style="list-style-type: none"> • Non-permissible welding gun • Welding gun wired incorrectly • Wrong adapter on the gun cable • Software or hardware error (troubleshooting can only done by Soyer customer service).

Notes on error messages

- In case of errors E01 to E04 and E06, the device switches to malfunction. Welding is no longer possible. The device can only be recommissioned when it is switched off and then switched on again.
- In the event of error code E05, excess temperature, the welding device cannot be used until the displayed error message disappears.



15. Maintenance and repair

Maintenance and repair of the stud welding device and the stud welding gun must only be performed by Heinz Soyer Bolzenschweißtechnik GmbH or authorised specialists.

16. Service

If servicing is required, please contact:

Heinz Soyer Bolzenschweißtechnik GmbH

Inninger Straße 14

82237 Wörthsee

Phone: 0049-8153-885-0

Fax: 0049-8153-8030

Email: info@soyer.de

Please have the serial number ready during service requests.

Alternatively, you can also contact your respective Soyer agent. Contact information can be found on our website at

www.soyer.de or

www.soyer.com (English)

17. Warranty conditions

The warranty period for commercial or equal use is 12 months. If repair is required, we guarantee the correction of the defects at the Etterschlag plant. Wearing parts are excluded.

The warranty claim shall expire if damage is caused through improper operation, repairs or interventions are undertaken by unauthorised persons and accessories and spare parts are used that are not intended for our system.

When using welding studs from external manufacturers, we do not assume any warranty for proper function of the stud welder and the quality of the welding joint.



Heinz Soyer Bolzenschweißtechnik GmbH

Inninger Straße 14

82237 Wörthsee

Tel.: 0049-8153-885-0

Mail: info@soyer.de

